

ZGNGR

VER1.2

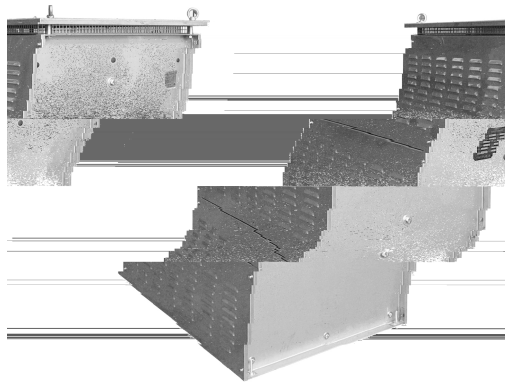

接地变或主变中性点

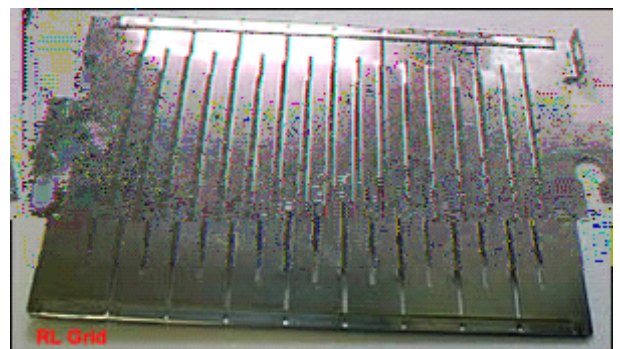

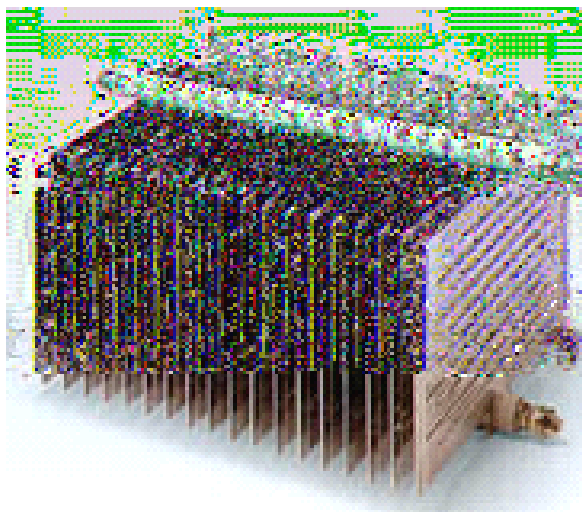

型号	系统额定电压 (kV)	短时允许通流 (A)	短时通流时间 (S)
ZGNGR6.3-600-10	6.3	600	10
ZGNGR6.3-500-10	6.3	500	10
ZGNGR6.3-400-10	6.3	400	10
ZGNGR6.3-200-10	6.3	200	10
ZGNGR6.3-100-10	6.3	100	10
ZGNGR6.3-10-10	6.3	10	10
ZGNGR10.5-800-10	10.5	800	10
ZGNGR10.5-600-10	10.5	600	10
ZGNGR10.5-500-10	10.5	500	10
ZGNGR10.5-400-10	10.5	400	10
ZGNGR10.5-200-10	10.5	200	10
ZGNGR10.5-100-10	10.5	100	10
ZGNGR10.5-60-10	10.5	60	10
ZGNGR10.5-30-10	10.5	30	10
ZGNGR10.5-10-10	10.5	10	10
ZGNGR10.5-6-10	10.5	6	10
ZGNGR20-630-10	20	630	10
ZGNGR20-1000-10	20	1000	10
ZGNGR35-3000-10	35	3000	10
ZGNGR35-2000-10	35	2000	10
ZGNGR35-1600-10	35	1600	10
ZGNGR35-1000-10	35	1000	10
ZGNGR35-500-10	35	500	10
ZGNGR35-400-10	35	400	10
ZGNGR35-200-10	35	200	10
ZGNGR35-100-10	35	100	10
ZGNGR35-20-10	35	20	10

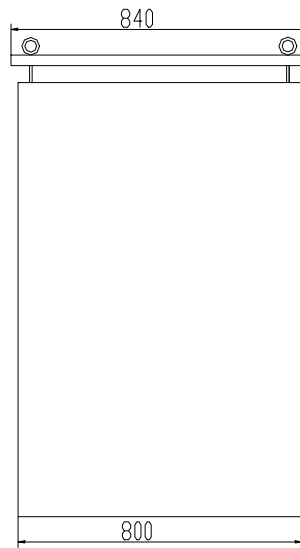
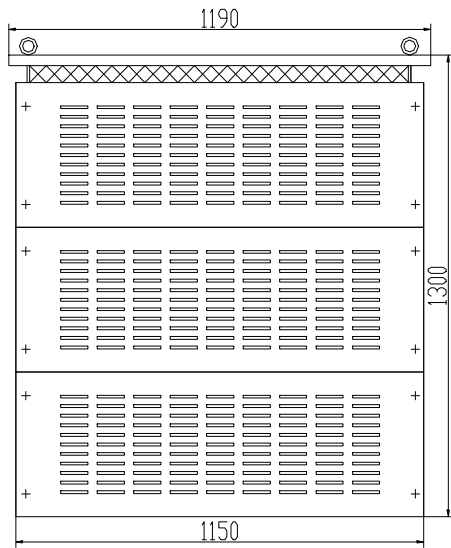
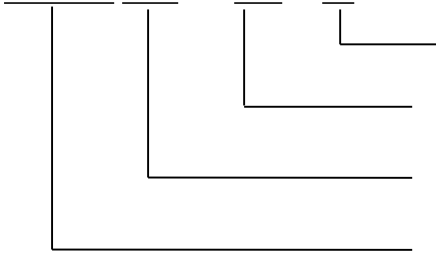

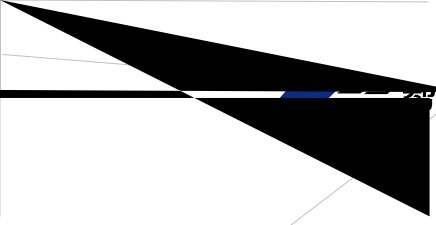

电气

